

ZOOMLION CRAWLER CRANE ZCC1500V-1



ZOOMLION

Zoomlion Heavy Industry Science & Technology Co.,Ltd.

Add: No.677, Lugu Road, Zoomlion Industrial Park, Changsha, Hunan, China, 410205

Copyright©2023 Zoomlion. All rights reserved. Reproduction and copying of any part of contents is not allowed for any purposes without Zoomlion's approval.



Product specifications are subject to change without notice and obligation. The photographs and/or drawing in this document are for illustrative purposes only. Please consult your local ZOOMLION dealer for more information.
website:en.zoomlion.com 2023.03.30

ZOOMLION

VISION CREATES FUTURE

ZOOMLION

CONTENTS 目录

ZCC1500V-1	DEMENSIONS	01
ZCC1500V-1	TECHNICAL HIGHLIGHTS	01
ZCC1500V-1	DESCRIPTION ON BOOM COMBINATION	02
ZCC1500V-1	TECHNICAL PARAMETERS	03
ZCC1500V-1	TRANSPORT DIMENSIONS AND WEIGHTS	04/08
ZCC1500V-1	TECHNICAL DESCRIPTION	09/10
ZCC1500V-1	LIFTING PERFORMANCE	11/18



DEMENSIONS

Overall dimensions of the crane

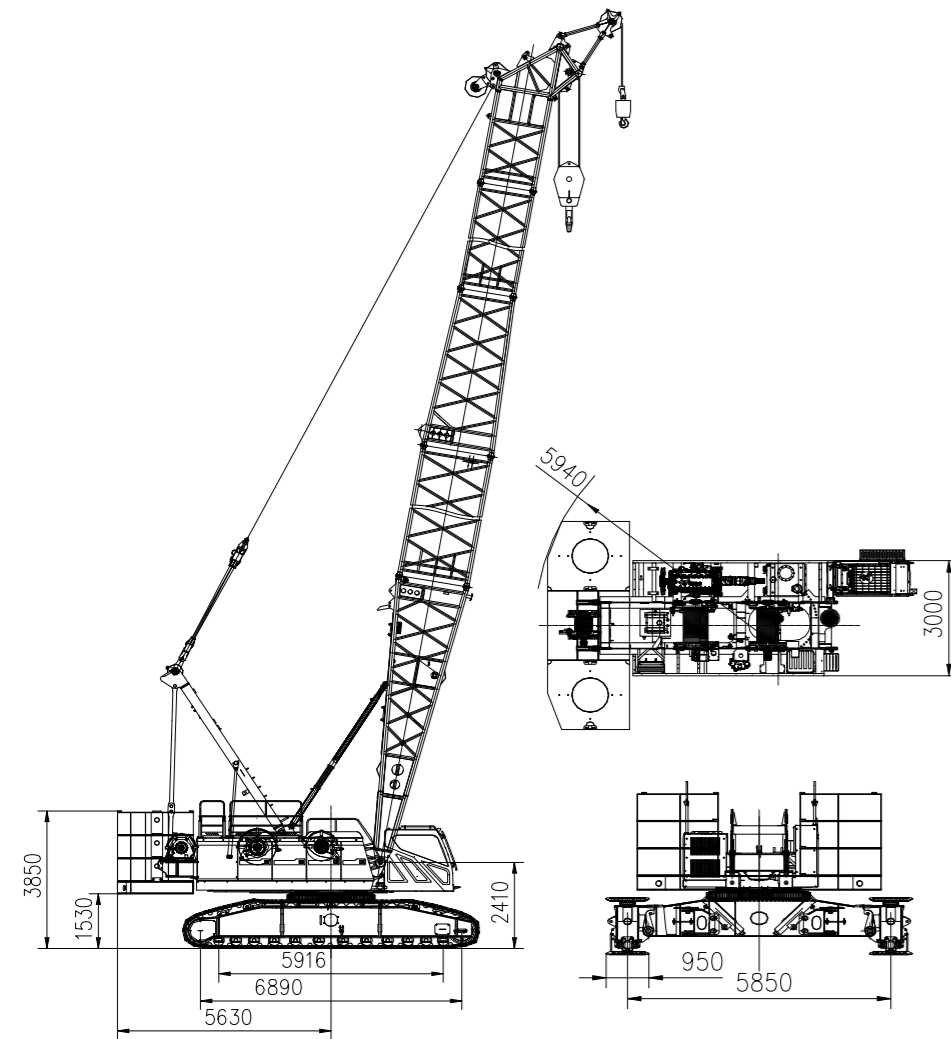

TECHNICAL HIGHLIGHTS

Multiple operating modes, satisfying various needs of lifting

- Available operating modes include: main boom operating mode (with tip boom), fixed jib operating mode, luffing jib operating mode, and foldable luffing jib operating mode.

Superior lifting performance and wide working radius

- Slewing radius $\leq 6m$ and shortest main boom of 16m; satisfying the need of lifting in narrow spaces.
- The maximum elevation angle of main boom with a foldable luffing jib is 87° . A ground with a length of only 68m is needed for the assembly of a 52m main boom and a 46m luffing jib.
- Selectable graded rear counterweight, relatively light weight of the basic machine and moderate track gauge.

Extremely low cost for transport and super high efficiency of assembly and disassembly Transport

- Transport weight of the basic machine with a pivot section $\leq 32t$; width of 3m and height of 3.2m; transported by a regular flatbed trailer.
- Transport of boom sections (one boom section fixed inside another; 3 pieces of boom sections can be fixed as a whole): full configuration for the operating mode of main boom + fixed jib can be transported with only five regular flatbed trailers.

Assembly and disassembly

- There is no need to assemble or disassemble the pivot section, which can be transported with the basic machine. An A-frame erecting cylinder is equipped to realize the erection of A-frame through power.

DESCRIPTION ON BOOM COMBINATION

Code	Operating mode	Parameters	Description
S	Main boom	16m-76m	Load on main boom
SH-1	Main boom + tip boom (main hook)	16m-76m	Main boom: loaded / Tip boom: unloaded
SH-2	Main boom + tip boom (auxiliary hook)	16m-76m	Main boom: unloaded / Tip boom: loaded
SF-1	Main boom + fixed jib (auxiliary hook, without main hook)	(28m-52m) + (13m-31m)	Fixed jib: loaded / Main boom: unloaded, no hook
SF-2	Main boom + fixed jib (auxiliary hook, with main hook)	(28m-52m) + (13m-31m)	Fixed jib: loaded / Main boom: unloaded, with hook
SF-3	Main boom + fixed jib (main hook)	(28m-52m) + (13m-31m)	Main boom: loaded / Fixed jib: unloaded but with hook
SW-1	Main boom + luffing jib (auxiliary hook)	(28m-52m) + (25m-46m)	Luffing jib: loaded / Main boom: unloaded, no hook
SW-2	Main boom + foldable luffing jib (auxiliary hook)	(28m-52m) + (25m-46m)	Foldable luffing jib: loaded / Main boom: unloaded, no hook

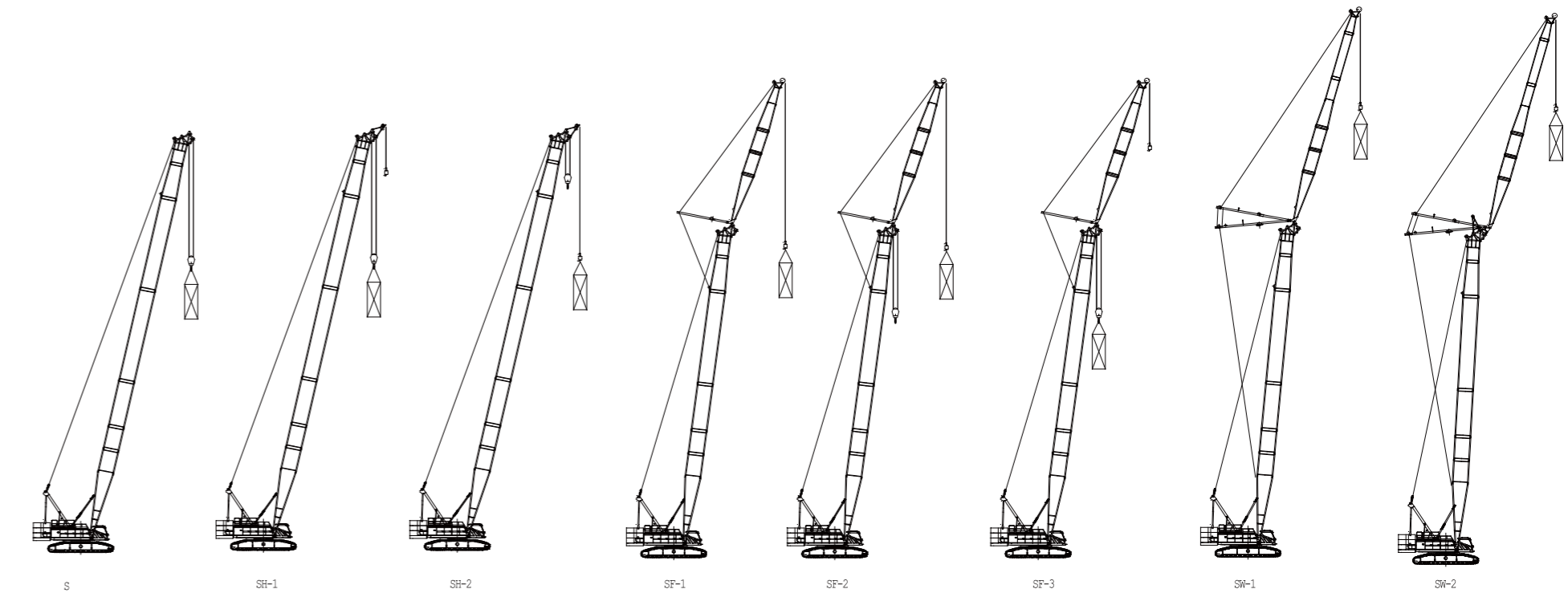

TECHNICAL PARAMETERS

Item	Unit	Values	Notes	
Main boom operating mode	Max.ratedliftingmoment	t·m	861	
	Max.ratedliftingcapacity×radius	t×m	150×5	
	Lengthofmainboom	m	16.76	
Fixed jib operating mode	Max.ratedliftingcapacity×radius	t×m	46.1×12	
	Lengthoffixedjib	m	13.31	
	Max.lengthofmainboom+jib	m	52+31	
Luffing jib operating mode	Fixedjibangle	°	10,30	
	Max.ratedliftingcapacity	t	52.7×12	
	Lengthofluffingjib	m	25.46	
Foldable luffing jib operating mode	Max.lengthofmainboom+jib	m	52+46	
	Max.ratedliftingcapacity	t	30×12	
	Lengthofluffingjib	m	25.46	
Mechanism speed	Max.lengthofmainboom+jib	m	52+46	
	Ropespeedofmainhoistingwinch	m/min	140	
	Ropespeedofsecondaryhoistingwinch	m/min	110	
Engine	Ropespeedofmaiderrickingwinch	m/min	68.3	
	Model/emissionstandard	L	WP10HG336E470	CHINAIVfor non-road mobile machinery
	Ratedpower/rotationalspeed	kW/rpm	247/1900	
Transport parameters	Max.outputtorque/rotationalspeed	kW/rpm	1600/1100-1400	
	Deadweightofcrawlercrane	t	145.83	Basicboomwithmainhook
	Counterweight	t	62	
Other parameters	Transportdimensionofbasicmachine(length×width×height)	m	17.6×3.0×3.31	Withpivotsection
	Averagegroundpressure(withbasicboom)	MPa	0.11	
	Gradeability	%	30	
Other parameters	Distancebetweentwotracks×contactlengthoftrack×widthoftrackpad	m	5.85×6.9×0.95	
	Slewingradius	m	5.94	

TRANSPORT DIMENSIONS AND WEIGHTS

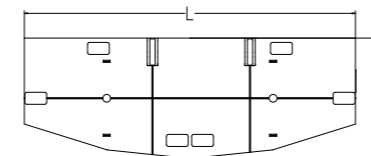
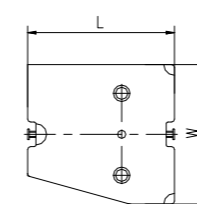
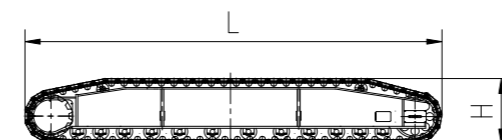
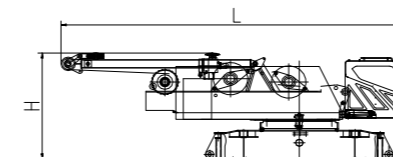
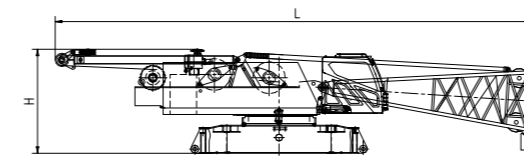

Basic machine 1	1 piece*
Length(L)	17600 mm
Width (W)	3000 mm
Height (H)	3310 mm
Weight	32500 kg

Note: with pivot section

Basic machine 1	1 pieces*
Length(L)	10100 mm
Width (W)	3000 mm
Height (H)	3310 mm
Weight	30000 kg

Without pivot section and tilting-back support

Crawler carrier assy	2 pieces
Length(L)	7830 mm
Width (W)	1180 mm
Height (H)	1385 mm
Weight	12500 kg

Central ballast	4 pieces
Length(L)	1790 mm
Width (W)	2000 mm
Height (H)	425 mm
Weight	5000 kg

Counterweight base	1 piece
Length(L)	6000 mm
Width (W)	2000 mm
Height (H)	1180 mm
Weight	14000 kg

TRANSPORT DIMENSIONS AND WEIGHTS

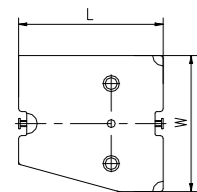

Counterweight slab 1	3 pieces
Length (L)	1790 mm
Width (W)	2000 mm
Height (H)	605 mm
Weight	8000 kg

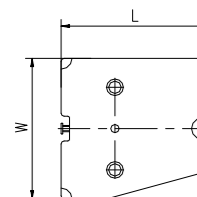

Counterweight slab 2	3 pieces
Length (L)	1790 mm
Width (W)	2000 mm
Height (H)	605 mm
Weight	8000 kg

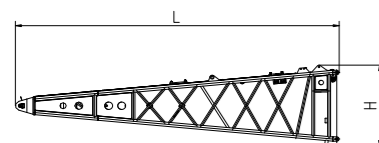

Main boom pivot section	1 piece
Length (L)	8185 mm
Width (W)	2220 mm
Height (H)	2200 mm
Weight	2332 kg

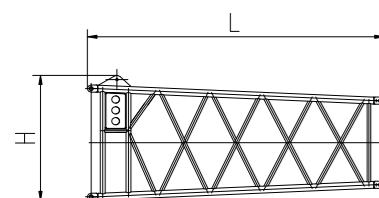

Main boom reducing section	1 piece
Length (L)	4620 mm
Width (W)	2220 mm
Height (H)	2080 mm
Weight	980 kg

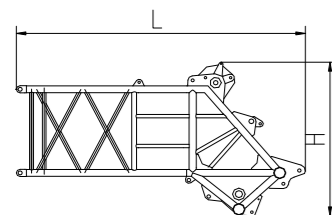

Main boom head section	1 piece
Length (L)	4570 mm
Width (W)	1840 mm
Height (H)	2700 mm
Weight	1940 kg

TRANSPORT DIMENSIONS AND WEIGHTS

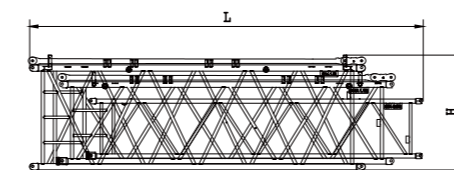

Package of 3m intermediate sections	2 pieces*
Length(L)	4180 mm
Width (W)	2220 mm
Height (H)	2100 mm
Weight	1413 kg

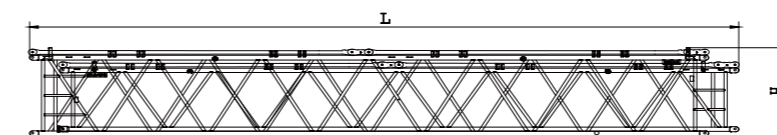

Package of 6m intermediate sections	1 piece*
Length(L)	7180 mm
Width (W)	2220 mm
Height (H)	2100 mm
Weight	2387 kg

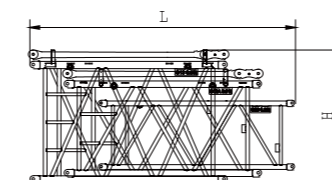

Package of 12m intermediate sections	2 pieces*
Length(L)	12700 mm
Width (W)	2220 mm
Height (H)	2100 mm
Weight	3741 kg

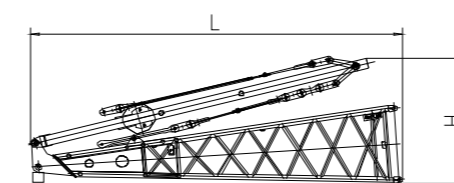

Fixed jib pivot section (with FA-frame and anchoring rods)	1 piece*
Length(L)	6740 mm
Width (W)	1820 mm
Height (H)	2340 mm
Weight	2126 kg

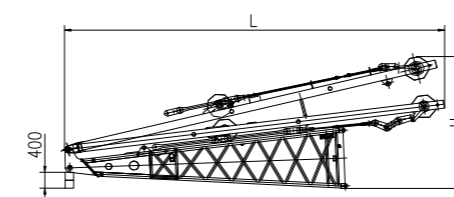

Luffing jib pivot section (with WA-frame and anchoring rods)	1 piece*
Length(L)	9000 mm
Width (W)	1820 mm
Height (H)	3320 mm
Weight	3687 kg

TRANSPORT DIMENSIONS AND WEIGHTS

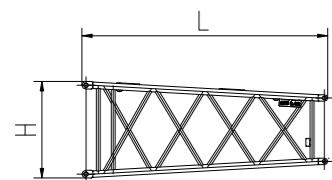

Jib reducing section	1 piece*
Length (L)	3610 mm
Width (W)	1840 mm
Height (H)	1250 mm
Weight	423 kg

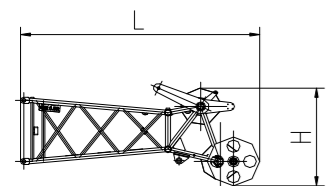

Jib head section	1 piece*
Length (L)	3650 mm
Width (W)	1330 mm
Height (H)	1600 mm
Weight	580 kg

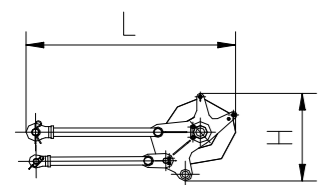

Tip boom	1 piece
Length (L)	1800 mm
Width (W)	1200 mm
Height (H)	800 mm
Weight	215 kg

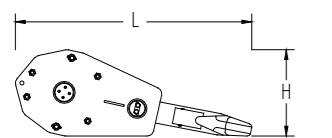

Hook (160t)	1 piece*
Length (L)	2000 mm
Width (W)	1070mm
Height (H)	780 mm
Weight	2221 kg

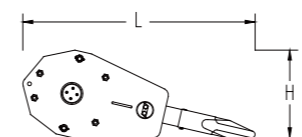

Hook (100t)	1 piece*
Length(L)	1810 mm
Width (W)	850 mm
Height (H)	780 mm
Weight	1656 kg

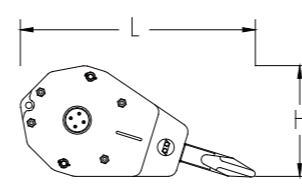

Hook (80t)	1 piece*
Length(L)	1800 mm
Width (W)	695 mm
Height (H)	790 mm
Weight	1414 kg

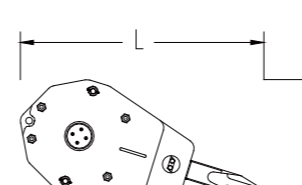

Hook (32t)	1 piece*
Length(L)	1630 mm
Width (W)	616 mm
Height (H)	780 mm
Weight	979 kg

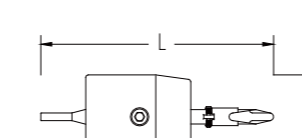

Hook (13.5t)	1 piece*
Length(L)	1060 mm
Width (W)	390 mm
Height (H)	390 mm
Weight	420 kg

Notes:

1. Figures in the above table are schematic diagrams that are not drawn in fixed proportions. Dimensions shown are general boundary dimensions.
2. Packaging weight is not included. Weights might be different from what are listed in the above table due to manufacturing error.
3. Dimensions of actual products shall prevail if dimensions and weights differ from what are listed above due to parts improvement.
4. Number of parts marked with * are determined by actual needs.

TECHNICAL DESCRIPTION



Power unit

Weichai electronic-injection diesel engine: WP10HG336E470.
 Rated power / rotational speed: 247kW/1900r/min.
 Maximum output torque / rotational speed: 1600N·m/1100~1400r/min.
 Emission standard: CHINA IV for non-road mobile machinery.
 Volume of fuel oil tank: 600L.



Hydraulic system

Hydraulic pump: two plunger pumps of famous brand; energy-saving, stable and reliable; it drives winches and the crawling mechanism; the triple gear pump is used for slewing, auxiliary operations and the dissipation of the hydraulic system.
 Control system: a pilot proportional control hydraulic system with a load feedback system; two hydraulic joysticks and two foot-operated crawling control valves are used for controlling different executive components.
 Volume of hydraulic oil tank: 620L.



Centralized display system

The large LCD touch screen of 10.4 inches displays in multiple languages. It displays all kinds of signals collected by the PLC controller.



GPS/GPRS remote monitoring system

GPS/GPRS remote monitoring system realizes such functions as global positioning of equipment, working information monitoring of equipment, fault diagnosis, remote maintenance, alarm, locking and theft prevention, etc.



Hoisting mechanism

Both the main hoisting winch and the secondary hoisting winch are driven by an axial hydraulic variable-displacement piston motor through a built-in planetary reducer. Braking of the spring on winch motor is controlled by the balancing valve. The reel with a double-rope groove guarantees that rope of multiple layers will not intertwine together.

	Main hoisting winch	Secondary hoisting winch
Rated single rope tension	13.5t	10.8t
Wire rope diameter	26mm	26mm
Wire rope length	340m	250m
Max. single rope speed	140m/min	110m/min



Derricking mechanism

The derricking winch is driven by an axial piston motor through a built-in planetary reducer and brakes through the spring on the motor end.
 Cable drum lock: The winch is locked by ratchet wheel and ratchet pawl.

	Derricking winch
Rated single rope tension	10t
Wire rope diameter	20mm
Wire rope length	230m
Max. single rope speed	68.3m/min

TECHNICAL DESCRIPTION



Slewing mechanism

The slewing mechanism is composed of hydraulic motor, slewing reducer, control valve and slewing bearing. Small gear of the output shaft rotates around the slewing bearing ring fixed on the chassis so that the slewing platform makes slewing movement of 360°.
 Maximum slewing speed: 1.23rpm.



Counterweight

The whole rear counterweight is suspended at the rear end of the slewing platform with counterweight slabs piled one on another. The total weight of the rear counterweight is 62t: the counterweight pallet weighs 14t and counterweight slabs weigh 48t (8t×6).
 Central ballast weighs 20t (5t×4).



Operator's cab

Operator's cab of exclusive use for crawler crane; switch-controlled cab-pitching mechanism (pitching range: 0°~15°)
 The seat in the cab is upgraded to an air-suspension soft seat
 Main hoisting winch, secondary hoisting winch, slewing and boom derricking are controlled by the cross pilot hydraulic-control joysticks.
 Radio; bluetooth speaker; USB charging port a color display of 10.4" and a monitoring screen; electric-drive cold/warm air conditioner.



Crawling mechanism

The crawling mechanism adopts dual motors and dual reducers. Crawling of the two tracks is controlled by the two levers respectively.
 Crawling speed: 0~1.2km/h.
 Gradeability: 30%.
 Tensioning of track: The track is tensioned by a jack.



Hook

Four types of hooks are available. Each hook is equipped with an anti-unhooking device.

Specification of hook	Weight of hook (Kg)	Number of pulleys
160 t	2221	7
100 t	1656	5
80 t	1414	3
32 t	979	1
13.5 t	420	0

Four types of hooks are available. Each hook is equipped with an anti-unhooking device.

Hook	Height
160t	3.5m
100t	3.3m
80t	3.3m
32t	3.2m
13.5t	2.7m

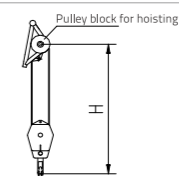

LIFTING PERFORMANCE

Hoisting height curves (SF, 10°)

Unit: m Hoisting height curves (SF, 10°)

Unit: m

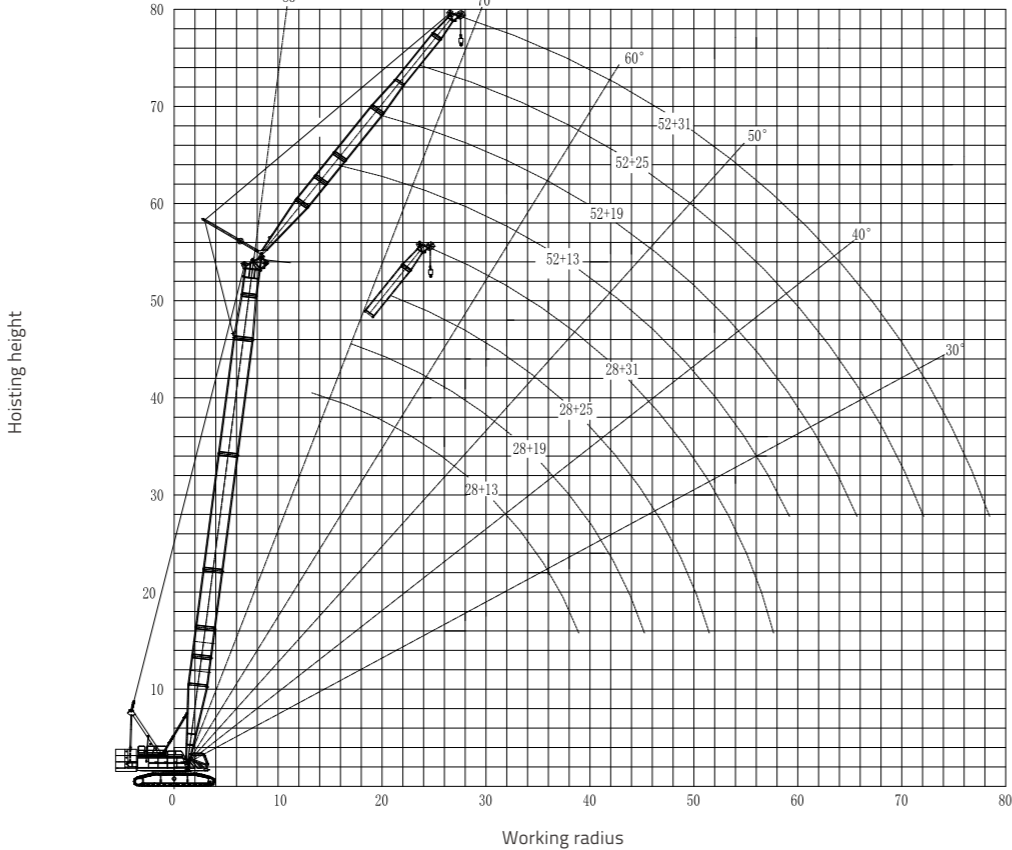
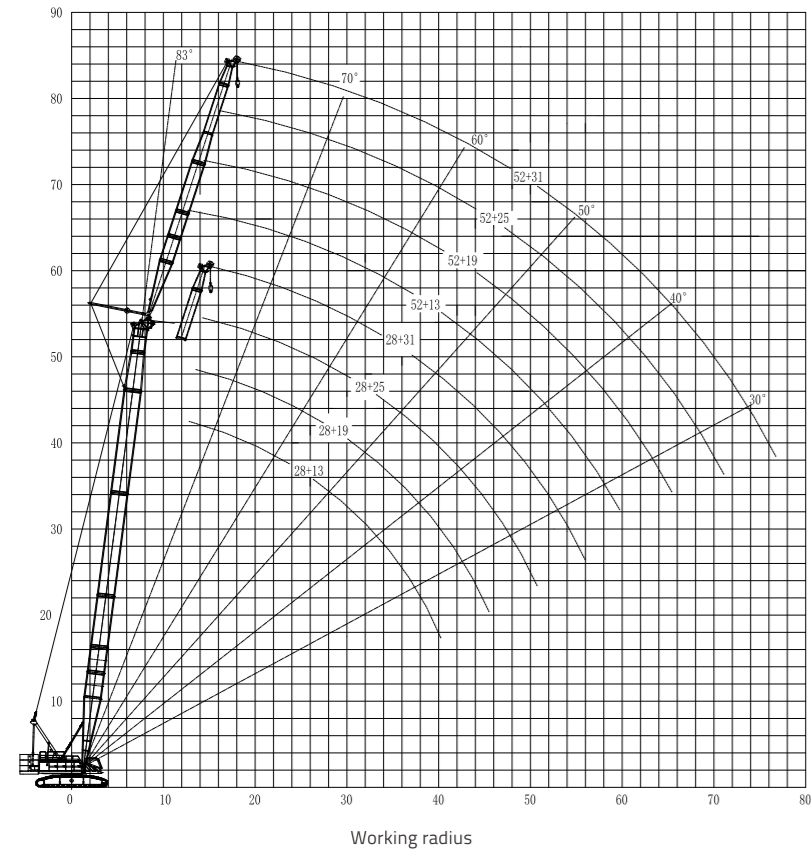

LIFTING PERFORMANCE

Unit: t

Unit: t

Radius (m)	Fixed jib length: 13m Included angle between main boom and jib: 10°								
	28	31	34	37	40	43	46	49	52
Main boom (m)	28	31	34	37	40	43	46	49	52
12	46.1								
14	42.2	42.3	42.5	42.6					
16	39.1	39.2	39.4	39.8	39.9	39.7	39.2	38.5	
18	36.4	36	35.6	35.1	34.7	34.3	33.9	33.5	33
20	32	31.6	31.2	30.8	30.5	30.1	29.7	29.3	28.9
22	28.3	28.1	27.8	27.4	27	26.7	26.3	26	25.6
24	25.1	25	24.9	24.5	24.2	23.9	23.5	23.2	22.9
26	22.5	22.4	22.2	22.1	21.8	21.5	21.2	20.9	20.6
28	20.3	20.2	20.1	19.9	19.7	19.5	19.2	18.9	18.6
30	18.5	18.4	18.2	18	17.8	17.7	17.5	17.2	16.9
32	16.9	16.7	16.6	16.4	16.2	16	15.9	15.7	15.4
34	15.5	15.3	15.2	14.9	14.8	14.6	14.5	14.3	14.1
36	14.2	14.1	13.9	13.7	13.5	13.4	13.2	13	12.8
38	13.1	13	12.8	12.6	12.4	12.3	12.1	11.9	11.7
40		12	11.8	11.6	11.4	11.3	11.1	10.9	10.7
42			10.9	10.7	10.5	10.4	10.2	10	9.8
44			10.1	9.9	9.7	9.6	9.4	9.2	9
46				9.2	9	8.9	8.7	8.5	8.3
48					8.3	8.2	8	7.8	7.6
50						7.6	7.4	7.2	7
52						7	6.8	6.6	6.4
54						6.3	6.1	5.9	
56							5.6	5.4	
58								5	
Reeving	4	4	4	4	3	3	3	3	3

Radius (m)	Fixed jib length: 31m Included angle between main boom and jib: 10°								
	28	31	34	37	40	43	46	49	52
Main boom (m)	28	31	34	37	40	43	46	49	52
20	20.7	20.6	20.5	20.5					
22	19.2	19.1	19	19.1	19.2	19.3	18.8	18.5	
24	17.9	17.8	17.8	17.8	17.9	18.1	17.8	17.5	17.2
26	16.8	16.7	16.7	16.8	16.9	17	16.7	16.5	16.2
28	15.7	15.7	15.7	15.8	15.9	16	15.9	15.6	15.3
30	14.8	14.8	14.8	14.9	15	15.2	15	14.8	14.6
32	14	14	14	14.2	14.3	14.4	14.3	14.1	13.9
34	13.3	13.3	13.3	13.4	13.5	13.6	13.3	13	12.7
36	12.5	12.6	12.6	12.8	12.6	12.4	12.2	11.9	11.6
38	11.9	12	11.9	11.7	11.5	11.3	11.1	10.9	10.6
40	11.2	11.1	10.9	10.7	10.5	10.3	10.1	10	9.7
42	10.3	10.2	10	9.8	9.6	9.4	9.2	9	8.9
44	9.5	9.4	9.2	9	8.8	8.6	8.4	8.2	8
46	8.8	8.6	8.4	8.2	8	7.8	7.7	7.5	7.3
48	8.1	7.9	7.7	7.5	7.3	7.2	7	6.8	6.6
50	7.5	7.3	7.1	6.9	6.7	6.5	6.4	6.2	6
52	6.9	6.7	6.6	6.3	6.1	6	5.8	5.6	5.4
54	6.4	6.2	6	5.8	5.6	5.4	5.3	5	4.8
56	5.9	5.7	5.5	5.3	5.1	4.9	4.8	4.5	4.3
58		5.3	5.1	4.9	4.6	4.5	4.3	4.1	3.9
60			4.6	4.4	4.2	4.1	3.9	3.7	3.5
62				4	3.8	3.7	3.5	3.3	3
64					3.4	3.3	3.1	2.9	2.7
Reeving	2	2	2	2	2	2	2	2	2

LIFTING PERFORMANCE

Hoisting height curves (SW-1)

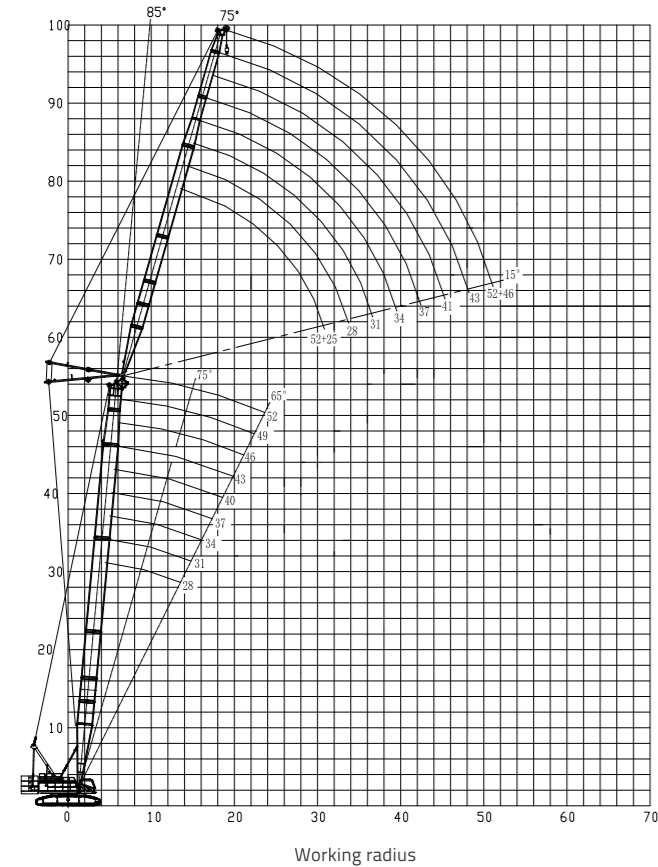

Unit: m

Radius (m)	Luffing jib length: 25m Main boom angle: 85°								
Main boom (m)	28	31	34	37	40	43	46	49	52
12	52.7	52.4							
14	47.3	47.4	47	46	45	44	42.7	38.7	34.2
16	42.7	42.2	41.4	40.6	39.8	38.9	38.2	34.9	30.8
18	37.4	37	36.6	36.2	35.6	34.9	34.3	31.6	27.9
20	33.3	32.9	32.6	32.2	31.9	31.5	31	28.9	25.5
22	29.9	29.6	29.3	29	28.7	28.4	28.1	26.5	23.3
24	26.9	26.9	26.6	26.4	26.1	25.8	25.5	24.4	21.4
26	23.1	23.6	24.2	24.2	23.9	23.7	23.4	22.5	19.7
28	18.1	19	20	20.9	21.5	21.9	21.6	20.8	18.2
30						16.7	17.6	18.5	16.7
Reeving	4	4	4	4	4	4	4	3	3

Unit: t

LIFTING PERFORMANCE

Unit: t

Radius (m)	Luffing jib length: 37m Main boom angle: 85°								
Main boom (m)	28	31	34	37	40	43	46	49	52
16	38.4	38.7	38.3	37.6	36.8	36.1			
18	35.2	35	34.3	33.6	33	32.4	31.7	30	27.1
20	31.6	31.3	30.9	30.4	29.9	29.3	28.8	27.4	24.7
22	28.4	28.1	27.8	27.5	27.2	26.8	26.2	25.1	22.6
24	25.8	25.5	25.2	24.9	24.7	24.4	24.1	23.1	20.7
26	23.5	23.3	23.1	22.8	22.6	22.3	22	21.4	19.1
28	21.6	21.4	21.2	21	20.8	20.5	20.3	19.8	17.6
30	20	19.8	19.6	19.4	19.2	19	18.8	18.3	16.3
32	18.3	18.4	18.2	18.1	17.9	17.7	17.5	17	15.1
34	16.5	16.8	17	16.9	16.7	16.5	16.3	15.8	14
36	14.8	15.1	15.4	15.7	15.6	15.5	15.3	14.7	12.9
38	13.1	13.5	13.8	14	14.1	14.4	14.4	13.6	11.9
40	11.1	11.7	12.1	12.4	12.5	12.7	13	12.6	11
42							11.5	10.1	
Reeving	3	3	3	3	3	3	3	3	3

Unit: t

Radius (m)	Luffing jib length: 40m Main boom angle: 65°								
Main boom (m)	28	31	34	37	40	43	46	49	52
16	37.2	37.5	37.5						
18	34.2	34.2	33.6	32.9	32.3	31.6	31	29.7	25.5
20	31.1	30.8	30.3	29.8	29.2	28.6	28.1	27.1	23.3
22	27.9	27.6	27.3	27	26.6	26.1	25.6	24.8	21.3
24	25.3	25	24.8	24.5	24.2	23.9	23.6	22.8	19.6
26	23.1	22.9	22.6	22.4	22.1	21.9	21.6	21.1	18
28	21.2	21	20.8	20.6	20.4	20.1	19.9	19.5	16.6
30	19.5	19.4	19.2	19	18.8	18.6	18.4	18.1	15.4
32	17.8	18	17.9	17.7	17.5	17.3	17.1	16.7	14.2
34	16.4	16.6	16.6	16.5	16.3	16.1	15.9	15.5	13.2
36	15.2	15.3	15.5	15.3	15.3	15.1	14.9	14.4	12.2
38	13.7	14	14.2	14.2	14.3	14.2	14	13.4	11.3
40	12.3	12.6	12.8	12.9	13.1	13.3	13.2	12.4	10.4
42	10.8	11.1	11.4	11.5	11.7	11.9	12.2	11.5	9.6
44				9.9	10.2	10.5	10.7	10.6	8.7
Reeving	3	3	3	3	3	3	3	3	3

Unit: t

LIFTING PERFORMANCE

Unit: t Hoisting height curves (SW-2)

Radius (m)	Luffing jib length: 46m Main boom angle: 65°									
Main boom (m)	28	31	34	37	40	43	46	49	52	
18	28.8	28.5	29	29.5	30					
20	25.1	24.8	25.2	25.7	26.2	26.7	25.6	24.9	22.3	
22	22.1	21.9	22.2	22.6	23	23.3	22.5	22.8	20.3	
24	19.6	19.3	19.7	19.9	20.3	20.6	19.8	20.2	18.6	
26	17.3	17.2	17.4	17.7	17.9	18.2	17.7	17.9	17.1	
28	15.4	15.3	15.5	15.8	16	16.2	15.7	15.9	15.7	
30	13.7	13.6	13.8	14	14.3	14.4	14	14.2	14.4	
32	12.3	12.2	12.4	12.5	12.7	12.9	12.5	12.7	12.9	
34	10.9	10.9	11	11.2	11.4	11.5	11.2	11.4	11.5	
36	9.8	9.7	9.8	10	10.2	10.3	10	10.2	10.3	
38	8.7	8.6	8.8	8.9	9	9.2	8.9	9	9.2	
40	7.7	7.7	7.9	8	8.1	8.2	8	8.1	8.2	
42	6.9	6.9	7	7.1	7.2	7.3	7.1	7.2	7.3	
44	6.1	6.1	6.2	6.3	6.4	6.5	6.3	6.4	6.5	
46	5.4	5.3	5.5	5.5	5.6	5.7	5.6	5.7	5.8	
48	4.7	4.7	4.8	4.9	5	5.1	4.9	5	5.1	
50					4.3	4.4	4.3	4.4	4.5	
Reeving	3	3	3	3	3	3	2	2	2	

Attention:
Lifting capacities of luffing jib in above tables are reference values. Refer to the Lifting Capacity Charts for specific data.

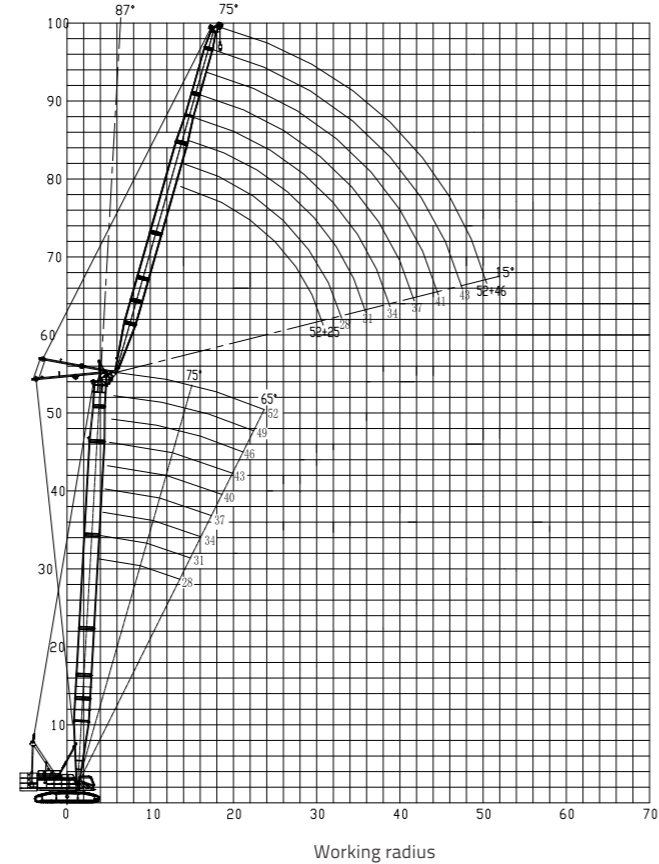

Unit: m

LIFTING PERFORMANCE

Unit: t

Main boom (m)	28			31			34												
Jib (m)	25			25			28			25			28			31			
Radius(m)	Main boom angle (°)																		
	87°	75°	65°	87°	75°	65°	87°	75°	65°	87°	75°	65°	87°	75°	65°	87°	75°	65°	
12	30			30			30			30			30						
14	30			30			30			30			30			30			
16	30			30			30			30			30			30			
18	30			30			30			30			30			30			
20	30			30			30			30			30			29.6			
22	27.8	25.4		27.6			27.3			27.4			27.1			26.6			
24	25.3	23		25.1	22.5		24.8	22.2		24.9	22		24.6			24.2			
26	23.1	21		22.9	20.6		22.7	20.3		22.8	20.1		22.5	19.9		22.1	19.4		
28	20.7	19.2		21	18.9		20.9	18.7		21	18.5		20.7	18.3		20.4	17.9		
30		17.6	16.2		17.4		19.2	17.3		17.1			19.2	16.9		18.9	16.5		
32		16.2	14.9		16	14.6	16	15.9		15.8			16.7	15.7		17.6	15.3		
34		15	13.8		14.8	13.5		14.7	13.3		14.6	13.1		14.5	12		16.2	14.3	
36			12.8		12.5		13.7	12.4		13.5	12.1		13.5	12		13.2	11.7		
38			11.9		11.6		12.7	11.5		11.3	10.9		11.3	10.5		12.3	10.9		
40					10.9			10.8		10.5	10.2		10.5	10.2		11.5	10.2		
42								10.1		9.8	9.5		9.8	9.5		10.7	9.5		
44														9.1		8.9			
46																8.3			
48																			
50																			

Main boom (m)	52																							
Jib (m)	25			28			31			34			37			40			43			46		
Radius(m)	Main boom angle (°)																							
	87°	75°	65°	87°	75°	65°	87°	75°	65°	87°	75°	65°	87°	75°	65°	87°	75°	65°	87°	75°	65°	87°	75°	65°
12																								
14	30						30																	
16	29.4						29																	
18	26.6						26.5																	
20	24.2						24.1																	
22	22.1						22.1																	
24	20.3						20.2																	
26	18.6						18.6																	
28	17.1	15.7					17.2																	
30	15.7	14.6					15.8	14.3																
32		13.5					14.5	13.3																
34		12.6					12.4	11.7																
36		11.8					11.6	11.2																
38		11.1					10.9	10.5																
40		10.4					10.3	9.9																
42							7.6	7.4																
44							7.1	7																
46							6.7	6.5																
48							6.2	6.1																
50								5.7																

Unit: t